

# C

## Small Tool Instruments Inside Measurement



**Holtest ABSOLUTE Borematic**



**Inside Micrometers**



**Bore Gages**

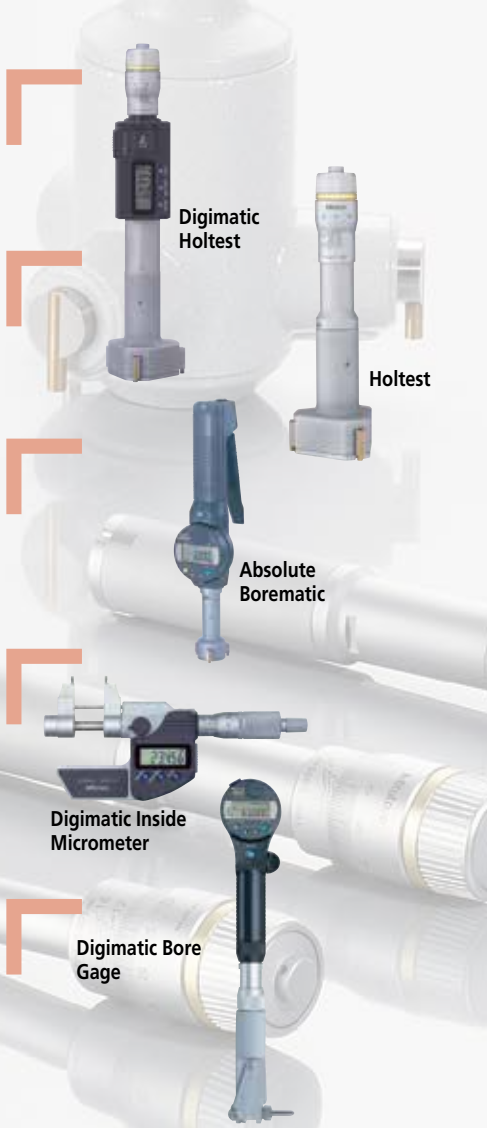

**Digimatic Holtest**

**Holtest**

**Absolute Borematic**

**Digimatic Inside Micrometer**

**Digimatic Bore Gage**

### INDEX

<b>Holtest</b>	
Digimatic Holtest	C-2,3
Holtest	C-4,5
Holtest (Type II)	C-6,7
Borematic	C-8,9
Holtest/Digimatic Holtest/Borematic	C-10
<b>Inside Micrometers</b>	
Tubular Inside Micrometers	C-11,12
Inside Micrometers	C-13
Digimatic Tubular Inside Micrometers	C-14
Tubular Inside Micrometers	C-15-17
Inside Micrometers	C-18
Inside Micro Checker	C-19
<b>Bore Gages</b>	
Bore Gages	C-20-26
ABSOLUTE Digimatic Bore Gage	C-27
Bore Gages	C-28
Bore Gage Zero Checker	C-29
Setting Rings	C-29,30

# Digimatic Holtest

## SERIES 468 — Three-Point Internal Micrometers

### FEATURES

- TiN-coated measuring contact points provide excellent durability and impact resistance and allow the instrument to measure to the bottom of a blind hole (up to 100mm / 4" models).
- Large LCD readout.
- Functions available: Presetting, Zero/ABS, Auto power On/Off, Data hold, Data output, Error alarm, Battery replacement alarm.
- With Ratchet Stop for constant force.
- Measure deep holes by attaching an extension rod (optional).
- Setting rings for origin point setting are optional.
- Supplied in fitted plastic case up to 100mm / 4" . Over 100mm / 4" supplied in wooden case.



468-261



468-263



468-274



TiN-coated contact points (" -10" suffix models only)

### DIMENSIONS AND MASS

Range	L	Mass (g)
6 - 8mm / .275 - .35"	59	400
8 - 10mm / .35 - .425"	59	400
10 - 12mm / .425 - .5"	59	400
12 - 16mm / .5 - .65"	84	430
16 - 20mm / .65 - .8"	84	430
20 - 25mm / .8 - 1"	93	500
25 - 30mm / 1 - 1.2"	93	510
30 - 40mm / 1.2 - 1.6"	103.8	510
40 - 50mm / 1.6 - 2"	103.8	530
50 - 63mm / 2 - 2.5"	105.4	650
62 - 75mm / 2.5 - 3.0"	105.4	660
75 - 88mm / 3.0 - 3.5"	105.4	990
87 - 100mm / 3.5 - 4.0"	105.4	1000
100 - 125mm / 4 - 5"	151.4	970
125 - 150mm / 5 - 6"	151.4	1060
150 - 175mm / 6 - 7"	151.4	1150
175 - 200mm / 7 - 8"	151.4	1240
200 - 225mm / 8 - 9"	151.4	1330
225 - 250mm / 9 - 10"	151.4	1420
250 - 275mm / 10 - 11"	151.4	1510
275 - 300mm / 11 - 12"	151.4	1600

Unit: mm

#### Measuring a Blind Hole

The measuring contact points held in the jaws permit measuring the diameter of a blind hole to the bottom.  
(up to 100mm / 4" models)

Range	a	b	c
6 - 12mm / .275 - .5"	2	—	2.5
12 - 20mm / .5 - .8"	0.3	5.6	3.5
20 - 30mm / .8 - 1.2"	0.3	8.3	5.2
30 - 50mm / 1.2 - 2"	0.3	13	10
50 - 100mm / 2 - 4"	0.3	17	14
100 - 300mm / 4 - 12"	12.4	21	13.8



### Technical Data

Accuracy: Refer to the list of specifications.  
 Resolution: 0.001mm or .00005"/0.001mm  
 (over 4 - 5" models: .0001"/0.001mm)  
 Contact point: TiN coating  
 Measuring method: Three-point method  
 Display: LCD  
 Battery: SR44 (2 pcs.), **938882**  
 Battery life: Approx. 1.2 years under normal use

### Function

Zero/ABS, Auto Power On/Off, Data hold, Data output,  
 Preset, inch/mm conversion (on inch/metric models only)  
 Alarm: Low voltage, Counting value composition error

### Optional Accessories

- 05CZA662:** SPC cable (1m / 40")
- 05CZA663:** SPC cable (2m / 80")
- 04AZB157:** Mounting plate for stand
- 156-101-10:** Stand
- 952322:** Extension rod 100mm / 3.94"  
For range 6-12mm / .275 - .5" models
- 952621:** Extension rod 150mm / 5.9"  
For range 12-20mm / .5" - .8" models
- 952622:** Extension rod 150mm / 5.9"  
For range 20-50mm / .8" - 2" models
- 952623:** Extension rod 150mm / 5.9"  
For range 50-300mm / 2" - 12" models



04AZB157

## SPECIFICATIONS

**Metric**  with TiN-coated contact points

Range	Accuracy	Order Code	
		Individual	Main Body Assembly
6-8	±2μm	<b>468-161</b>	04AZB106
8-10		<b>468-162</b>	
10-12		<b>468-163</b>	
12-16		<b>468-164</b>	
16-20		<b>468-165</b>	
20-25	±3μm	<b>468-166</b>	04AZB108
25-30		<b>468-167</b>	
30-40		<b>468-168</b>	
40-50		<b>468-169</b>	
50-63		<b>468-170</b>	
62-75	±5μm	<b>468-171</b>	04AZB109
75-88		<b>468-172</b>	
87-100		<b>468-173</b>	
100-125		<b>468-174</b>	
125-150		<b>468-175</b>	
150-175	±5μm	<b>468-176</b>	04AZB110
175-200		<b>468-177</b>	
200-225		<b>468-178</b>	
225-250		<b>468-179</b>	
250-275		<b>468-180</b>	
275-300		<b>468-181</b>	

**Inch/Metric**  with TiN-coated contact points

Range	Accuracy	Order Code	
		Individual	Main Body Assembly
.275-.35"/6.925-8.89mm	±.0001"	<b>468-261</b>	04AZB111
.35-.425"/8.89-10.795mm		<b>468-262</b>	
.425-.5"/10.795-12.7mm		<b>468-263</b>	
.5-.65"/12.7-16.51mm		<b>468-264</b>	
.65-.8"/16.51-20.32mm		<b>468-265</b>	
.8-1"/20.32-25.4mm	±.00015"	<b>468-266</b>	04AZB112
1-1.2"/25.4-30.48mm		<b>468-267</b>	
1.2-1.6"/30.48-40.64mm		<b>468-268</b>	
1.6-2"/40.64-50.8mm		<b>468-269</b>	
2-2.5"/50.8-63.5mm		<b>468-270</b>	
2.5-3"/63.5-76.2mm	±.00025"	<b>468-271</b>	04AZB114
3-3.5"/76.2-88.9mm		<b>468-272</b>	
3.5-4"/88.9-101.6mm		<b>468-273</b>	
4-5"/101.6-127mm		<b>468-274</b>	
5-6"/127-152.4mm		<b>468-275</b>	
6-7"/152.4-177.8mm	±.00025"	<b>468-276</b>	04AZB115
7-8"/177.8-203.2mm		<b>468-277</b>	
8-9"/203.2-228.6mm		<b>468-278</b>	
9-10"/228.6-254mm		<b>468-279</b>	
10-11"/254-279.4mm		<b>468-280</b>	
11-12"/279.4-304.8mm		<b>468-281</b>	



468-986

### Complete Unit Set

Each set includes complete gages (display units and measuring heads for each size).

**Metric**  with TiN-coated contact points

Range	Order No.	Individual range	Setting rings included	Remarks
6 - 12mm	<b>468-981</b>	6-8, 8-10, 10-12mm	ø8mm, ø10mm	—
12 - 25mm	<b>468-982</b>	12-16, 16-20, 20-25mm	ø16mm, ø20mm	—
25 - 50mm	<b>468-983</b>	25-30, 30-40, 40-50mm	ø30mm, ø40mm	—
50 - 75mm	<b>468-984</b>	50-63, 62-75mm	ø62mm	—
75 - 100mm	<b>468-985</b>	75-88, 87-100mm	ø87mm	—

**Inch/Metric**  with TiN-coated contact points

Range	Order No.	Individual range	Setting rings included	Remarks
.275 - .5" / 6.925 - 12.7mm	<b>468-986</b>	.275-.35", .35-.425", .425-.5"	.35" DIA., .425" DIA.	—
.5 - 1" / 12.7 - 25.4mm	<b>468-987</b>	.5-.65", .65-.8", .8-1"	.65" DIA., .8" DIA.	—
1 - 2" / 25.4 - 50.8mm	<b>468-988</b>	1-1.2", 1.2-1.6", 1.6-2"	1.2" DIA., 1.6" DIA.	—
2 - 3" / 50.8 - 76.2mm	<b>468-989</b>	2-2.5", 2.5-3"	2.5" DIA.	—
3 - 4" / 76.2 - 101.6mm	<b>468-990</b>	3-3.5", 3.5-4"	3.5" DIA.	—



468-978

### Interchangeable Head Set

Each set includes one display unit with interchangeable measuring heads of the sizes specified.

**Metric**  with TiN-coated contact points

Range	Order No.	Individual range	Setting rings included	Remarks
6 - 12mm	<b>468-971</b>	6-8, 8-10, 10-12mm	ø8mm, ø10mm	with extension rod
12 - 20mm	<b>468-972</b>	12-16, 16-20mm	ø16mm.	with extension rod
20 - 50mm	<b>468-973</b>	20-25, 25-30, 30-40, 40-50mm	ø25mm, ø40mm	with extension rod
50 - 100mm	<b>468-974</b>	50-63, 62-75, 75-88, 87-100mm	ø62mm, ø87mm	with extension rod
100 - 200mm	<b>468-975</b>	100-125, 125-150, 150-175, 175-200mm	ø125mm, ø175mm	with extension rod

**Inch/Metric**  with TiN-coated contact points

Range	Order No.	Individual range	Setting rings included	Remarks
.275 - .5" / 6.925 - 12.7mm	<b>468-976</b>	.275-.35", .35-.425", .425-.5"	.35" DIA., .425" DIA.	with extension rod
.5 - .8" / 12.7 - 20.32mm	<b>468-977</b>	.5-.65", .65-.8"	.65" DIA.	with extension rod
.8 - 2" / 20.32 - 50.8mm	<b>468-978</b>	.8-1", 1-1.2", 1.2-1.6", 1.6-2"	1" DIA., 1.6" DIA.	with extension rod
2 - 4" / 50.8 - 101.6mm	<b>468-979</b>	2-2.5", 2.5-3", 3-3.5", 3.5-4"	2.5" DIA., 3.5" DIA.	with extension rod
4 - 8" / 101.6 - 203.2mm	<b>468-980</b>	4-5", 5-6", 6-7", 7-8"	5" DIA., 7" DIA.	with extension rod

# Holtest

## SERIES 368 — Three-Point/Two-Point Internal Micrometers

These Holtests are versatile, self-centering three-point internal micrometers for the accurate and efficient direct-measurement of internal diameters. Three anvils, evenly spaced at 120° apart, contact the internal wall surfaces and find true alignment with the axis of the bore for accurate ID measurement.



368-268

368-174

### FEATURES

- TiN-coated measuring contact points (over 6mm / .275" range models) provide excellent durability and impact resistance and allow the instrument to measure to the bottom of a blind hole (up to 100mm / 4" models).
- Highly durable because of carbide-tipped contact points (anvils up to 12mm / .5" models).
- Measure deep holes using an extension rod (optional) which is available on models over 6mm (.275") measuring range.
- With Ratchet Stop for constant force.
- Setting rings for zero point adjustment are optional.
- Supplied in fitted plastic case up to 100mm / 4". Over 100mm / 4" supplied in wooden case.

368-001

### Two-point contact type



TiN-coated contact points (excluding models up to 12mm/.5")

### DIMENSIONS

#### Measuring a Blind Hole

The measuring contact points held in the jaws permit measuring the diameter of a blind hole right down to the bottom (up to 100mm / 4" models).

Unit: mm

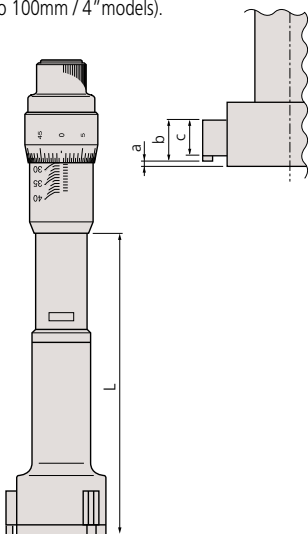

Range	L	Mass (g)	Range	L	Mass (g)
2 - 2.5mm / .08 - .1"	12	88	40 - 50mm / 1.6 - 2"	102	330
2.5 - 3mm / .1 - .12"	12	88	50 - 63mm / 2 - 2.5"	105	440
3 - 4mm / .12 - .16"	22	91	62 - 75mm / 2.5 - 3"	105	450
4 - 5mm / .16 - .2"	22	91	75 - 88mm / 3 - 3.5"	105	490
5 - 6mm / .2 - .24"	22	91	87 - 100mm / 3.5 - 4"	105	500
6 - 8mm / .275 - .35"	59	57	100 - 125mm / 4 - 5"	161	1050
8 - 10mm / .35 - .425"	59	58	125 - 150mm / 5 - 6"	161	1120
10 - 12mm / .425 - .5"	59	59	150 - 175mm / 6 - 7"	161	1190
12 - 16mm / .5 - .65"	82	140	175 - 200mm / 7 - 8"	161	1260
16 - 20mm / .65 - .8"	82	145	200 - 225mm / 8 - 9"	161	1420
20 - 25mm / .8 - 1"	94	250	225 - 250mm / 9 - 10"	161	1580
25 - 30mm / 1 - 1.2"	94	270	250 - 275mm / 10 - 11"	161	1600
30 - 40mm / 1.2 - 1.6"	102	290	275 - 300mm / 11 - 12"	161	1690

Range	a	b	c
2 - 6mm / .08 - .275"	—	—	2
6 - 12mm / .275 - .5"	2	—	2.5
12 - 20mm / .5 - .8"	0.3	5.6	3.5
20 - 30mm / .8 - 1.2"	0.3	8.3	5.2
30 - 50mm / 1.2 - 2"	0.3	13	10
50 - 100mm / 2 - 4"	0.3	17	14
100 - 300mm / 4 - 12"	12.4	21	13.8



### Technical Data

Graduation: 0.001mm, 0.005mm\*, .0001" or .0002"\*  
(\*over 12mm or .5" models)

Range	Measuring method	Contact-point material
2-6mm/.08-.28"	Two-point method	Carbide
6-300mm/.275-12"	Three-point method	TiN coating (1700-2000HV)

### Optional Accessories

- 952322:** Extension rod 100mm / 3.94"  
For range 6-12mm / .275-.5" models
- 952621:** Extension rod 150mm / 5.9"  
For range 12-20mm / .5" - .8" models
- 952622:** Extension rod 150mm / 5.9"  
For range 20-50mm / .8" - 2" models
- 952623:** Extension rod 150mm / 5.9"  
For range 50-300mm / 2"-12" models

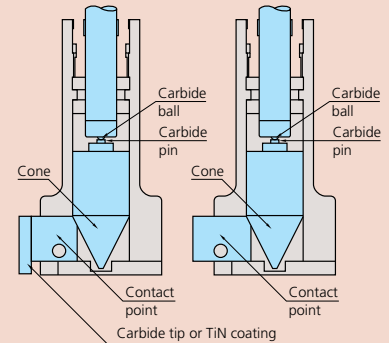

Using the optional extension rod



## SPECIFICATIONS

**Metric**  Individual  with TiN-coated contact points

Range	Order No.	Accuracy
2 - 2.5mm	<b>368-001</b>	±2μm
2.5 - 3mm	<b>368-002</b>	±2μm
3 - 4mm	<b>368-003</b>	±2μm
4 - 5mm	<b>368-004</b>	±2μm
5 - 6mm	<b>368-005</b>	±2μm
6 - 8mm	<b>368-161</b>	±2μm
8 - 10mm	<b>368-162</b>	±2μm
10 - 12mm	<b>368-163</b>	±2μm
12 - 16mm	<b>368-164</b>	±2μm
16 - 20mm	<b>368-165</b>	±2μm
20 - 25mm	<b>368-166</b>	±3μm
25 - 30mm	<b>368-167</b>	±3μm
30 - 40mm	<b>368-168</b>	±3μm
40 - 50mm	<b>368-169</b>	±3μm
50 - 63mm	<b>368-170</b>	±3μm
62 - 75mm	<b>368-171</b>	±3μm
75 - 88mm	<b>368-172</b>	±3μm
87 - 100mm	<b>368-173</b>	±3μm
100 - 125mm	<b>368-174</b>	±5μm
125 - 150mm	<b>368-175</b>	±5μm
150 - 175mm	<b>368-176</b>	±5μm
175 - 200mm	<b>368-177</b>	±5μm
200 - 225mm	<b>368-178</b>	±5μm
225 - 250mm	<b>368-179</b>	±5μm
250 - 275mm	<b>368-180</b>	±5μm
275 - 300mm	<b>368-181</b>	±5μm

**Inch**  Individual  with TiN-coated contact points

Range	Order No.	Accuracy
.08 - .1"	<b>368-021</b>	±.0001"
.1 - .12"	<b>368-022</b>	±.0001"
.12 - .16"	<b>368-023</b>	±.0001"
.16 - .2"	<b>368-024</b>	±.0001"
.2 - .24"	<b>368-025</b>	±.0001"
.24 - .28"	<b>368-026</b>	±.0001"
.275 - .35"	<b>368-261</b>	±.0001"
.35 - .425"	<b>368-262</b>	±.0001"
.425 - .5"	<b>368-263</b>	±.0001"
.5 - .65"	<b>368-264</b>	±.0001"
.65 - .8"	<b>368-265</b>	±.0001"
.8 - 1"	<b>368-266</b>	±.00015"
1 - 1.2"	<b>368-267</b>	±.00015"
1.2 - 1.6"	<b>368-268</b>	±.00015"
1.6 - 2"	<b>368-269</b>	±.00015"
2 - 2.5"	<b>368-270</b>	±.00015"
2.5 - 3"	<b>368-271</b>	±.00015"
3 - 3.5"	<b>368-272</b>	±.00015"
3.5 - 4"	<b>368-273</b>	±.00015"
4 - 5"	<b>368-274</b>	±.00025"
5 - 6"	<b>368-275</b>	±.00025"
6 - 7"	<b>368-276</b>	±.00025"
7 - 8"	<b>368-277</b>	±.00025"
8 - 9"	<b>368-278</b>	±.00025"
9 - 10"	<b>368-279</b>	±.00025"
10 - 11"	<b>368-280</b>	±.00025"
11 - 12"	<b>368-281</b>	±.00025"

### Complete Unit Set

Each set includes complete gages (micrometer head units and measuring heads for each size).

**Metric**  with TiN-coated contact points

Range	Order No.	Individual range	Setting rings included	Remarks
2 - 3mm	<b>368-906</b>	2-2.5, 2.5-3mm	ø2.5mm	—
3 - 6mm	<b>368-907</b>	3-4, 4-5, 5-6mm	ø4mm, ø5mm	—
6 - 12mm	<b>368-911</b>	6-8, 8-10, 10-12mm	ø8mm, ø10mm	with extension rod
12 - 20mm	<b>368-912</b>	12-16, 16-20mm	ø16mm	with extension rod
20 - 50mm	<b>368-913</b>	20-25, 25-30, 30-40, 40-50mm	ø25mm, ø40mm	with extension rod
50 - 100mm	<b>368-914</b>	50-63, 62-75, 75-88, 87-100mm	ø62mm, ø87mm	with extension rod
100 - 200mm	<b>368-915</b>	100-125, 125-150, 150-175, 175-200mm	ø125mm, ø175mm	with extension rod

**Inch**  with TiN-coated contact points

Range	Order No.	Individual range	Setting rings included	Remarks
.08" - .12"	<b>368-926</b>	.08-.1", .1-.12"	.1" DIA.	—
.12" - .28"	<b>368-927</b>	.12-.16", .16-.2", .2-.24", .24-.28"	.16" DIA., .24" DIA.	—
.275" - .5"	<b>368-916</b>	.275-.35", .35-.425", .425-.5"	.35" DIA., .5" DIA.	with extension rod
.5" - .8"	<b>368-917</b>	.5-.65", .65-.8"	.65" DIA.	with extension rod
.8" - 2"	<b>368-918</b>	.8-1", 1-1.2", 1.2-1.6", 1.6-2"	1" DIA., 1.6" DIA.	with extension rod
2" - 4"	<b>368-919</b>	2-2.5", 2.5-3", 3-3.5", 3.5-4"	2.5" DIA., 3.5" DIA.	with extension rod
4" - 8"	<b>368-920</b>	4-5", 5-6", 6-7", 7-8"	5" DIA., 7" DIA.	with extension rod

\*.0001" graduation



368-906



368-911

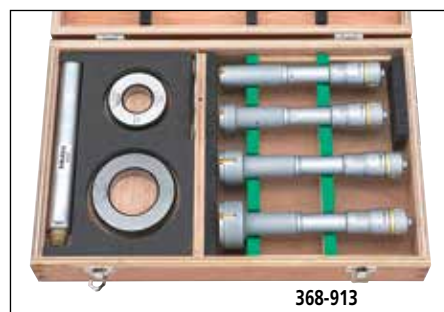

368-913

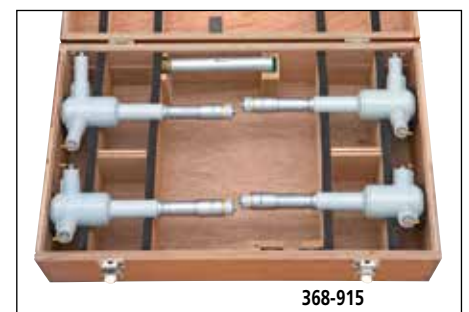

368-915

# Holtest (Type II)

## SERIES 368 — Three-Point Internal Micrometers

### FEATURES

- The Holtests (type II) have three contact points made of alloy steel.
- Measurement can be taken closer to the bottom of the blind bore (up to 100mm / 4" models).
- Measure deep holes using an extension rod (optional).
- With Ratchet Stop for constant force.
- Setting rings for origin point settings are optional.
- Supplied in fitted plastic case up to 100mm / 4". Over 100mm / 4" supplied in wooden case.



368-869



368-770



368-774

### DIMENSIONS AND MASS

Range	L	Mass (g)
12 - 16mm / .5 - .65"	82	150
16 - 20mm / .65 - .8"	82	150
20 - 25mm / .8 - 1"	94	260
25 - 30mm / 1 - 1.2"	94	280
30 - 40mm / 1.2 - 1.6"	102	290
40 - 50mm / 1.6 - 2"	102	330
50 - 63mm / 2 - 2.5"	105	440
62 - 75mm / 2.5 - 3"	105	450
75 - 88mm / 3 - 3.5"	105	560
87 - 100mm / 3.5 - 4"	105	570
100 - 125mm / 4 - 5"	161	1020
125 - 150mm / 5 - 6"	161	1110
150 - 175mm / 6 - 7"	161	1200
175 - 200mm / 7 - 8"	161	1300
200 - 225mm / 8 - 9"	161	1420
225 - 250mm / 9 - 10"	161	1540
250 - 275mm / 10 - 11"	161	1690
275 - 300mm / 11 - 12"	161	1860

  

Range	a	b
12 - 20mm / .5 - .8"	2.6	3.5
20 - 30mm / .8 - .12"	3.4	5.2
30 - 50mm / 1.2 - 2"	3.4	10
50 - 100mm / 2 - 4"	3.4	14
100 - 300mm / 4 - 12"	19.6	13.8

Unit: mm

#### Measuring a Blind Hole

The measuring contact points held in the jaws permit measuring the diameter of a blind hole right down to the bottom (up to 100mm / 4" models).

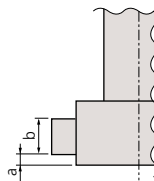

### Technical Data

Graduation: 0.005mm or .0002"

Measuring method: Three-point method

Contact point: Hardened steel (over HRC 60)

### Optional Accessories

**952621:** Extension rod 150mm / 5.9"  
For range 12-20mm / .5 - .8" models

**952622:** Extension rod 150mm / 5.9"  
For range 20-50mm / .8 - 2" models

**952623:** Extension rod 150mm / 5.9"  
For range 50-300mm / 2 - 12" models

## SPECIFICATIONS

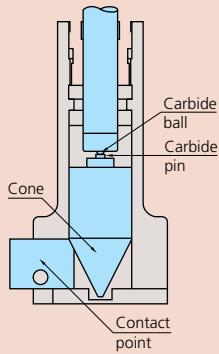

### HT (Type II)

Head Assy Order No.	Measuring Range	HT (type II) Order No.
04AZA839	12 - 16mm	368-764
04AZA840	16 - 20mm	368-765
04AZA848	20 - 25mm	368-766
04AZA849	25 - 30mm	368-767
04AZA857	30 - 40mm	368-768
04AZA858	40 - 50mm	368-769
04AZA870	50 - 63mm	368-770
04AZA871	62 - 75mm	368-771
04AZA872	75 - 88mm	368-772
04AZA873	87 - 100mm	368-773
04AZA895	100 - 125mm	368-774
04AZA896	125 - 150mm	368-775
04AZA897	150 - 175mm	368-776
04AZA898	175 - 200mm	368-777
04AZA899	200 - 225mm	368-778
04AZA900	225 - 250mm	368-779
04AZA901	250 - 275mm	368-780
04AZA902	275 - 300mm	368-781
04AZA841	.5 - .65"	368-864
04AZA842	.65 - .8"	368-865
04AZA850	.8 - 1"	368-866
04AZA851	1 - 1.2"	368-867
04AZA859	1.2 - 1.6"	368-868
04AZA860	1.6 - 2"	368-869
04AZA874	2 - 2.5"	368-870
04AZA875	2.5 - 3"	368-871
04AZA876	3 - 3.5"	368-872
04AZA877	3.5 - 4"	368-873
04AZA903	4 - 5"	368-874
04AZA904	5 - 6"	368-875
04AZA905	6 - 7"	368-876
04AZA906	7 - 8"	368-877
04AZA907	8 - 9"	368-878
04AZA908	9 - 10"	368-879
04AZA909	10 - 11"	368-880
04AZA910	11 - 12"	368-881

Metric Individual		
Range	Order No.	Accuracy
12 - 16mm	368-764	±2µm
16 - 20mm	368-765	±2µm
20 - 25mm	368-766	±3µm
25 - 30mm	368-767	±3µm
30 - 40mm	368-768	±3µm
40 - 50mm	368-769	±3µm
50 - 63mm	368-770	±3µm
62 - 75mm	368-771	±3µm
75 - 88mm	368-772	±3µm
87 - 100mm	368-773	±3µm
100 - 125mm	368-774	±5µm
125 - 150mm	368-775	±5µm
150 - 175mm	368-776	±5µm
175 - 200mm	368-777	±5µm
200 - 225mm	368-778	±5µm
225 - 250mm	368-779	±5µm
250 - 275mm	368-780	±5µm
275 - 300mm	368-781	±5µm

Inch Individual		
Range	Order No.	Accuracy
.5 - .65"	368-864	±.0001"
.65 - .8"	368-865	±.0001"
.8 - 1"	368-866	±.00015"
1 - 1.2"	368-867	±.00015"
1.2 - 1.6"	368-868	±.00015"
1.6 - 2"	368-869	±.00015"
2 - 2.5"	368-870	±.00015"
2.5 - 3"	368-871	±.00015"
3 - 3.5"	368-872	±.00015"
3.5 - 4"	368-873	±.00015"
4 - 5"	368-874	±.00025"
5 - 6"	368-875	±.00025"
6 - 7"	368-876	±.00025"
7 - 8"	368-877	±.00025"
8 - 9"	368-878	±.00025"
9 - 10"	368-879	±.00025"
10 - 11"	368-880	±.00025"
11 - 12"	368-881	±.00025"

### Complete Unit Set

Each set includes complete gages (micrometer head units and measuring heads for each size).

Metric				
Range	Order No.	Individual range	Setting rings included	Remarks
12 - 20mm	368-991	12-16, 16-20mm	ø16mm	with extension rod
20 - 50mm	368-992	20-25, 25-30, 30-40, 40-50mm	ø25mm, ø40mm	with extension rod
50 - 100mm	368-993	50-63, 62-75, 75-88, 87-100mm	ø62mm, ø87mm	with extension rod
100 - 200mm	368-994	100-125, 125-150, 150-175, 175-200mm	ø125mm, ø175mm	with extension rod

Inch				
Range	Order No.	Individual range	Setting rings included	Remarks
.5" - .8"	368-995	.5-.65", .65-.8"	.65" DIA.	with extension rod
.8" - 2"	368-996	.8-1", 1-1.2", 1.2-1.6", 1.6-2"	1" DIA., 1.6" DIA.	with extension rod
2" - 4"	368-997	2-2.5", 2.5-3", 3-3.5", 3.5-4"	2.5" DIA., 3.5" DIA.	with extension rod
4" - 8"	368-998	4-5", 5-6", 6-7", 7-8"	5" DIA., 7" DIA.	with extension rod



# Holtest/Digimatic Holtest/Borematic

## SERIES 368, 468, 568 Replacement Head Assembly List

TiN-coated measuring contact head assembly

Head Assy Order No.	Measuring Range	HT(Type I)		HTD		SBM		Adaptor*
		Order No.	Model	Order No.	Model	Order No.	Model	
04AZB136	6 - 8mm	368-161	HT-8R	468-161	HTD-8R	568-361	SBM-8C	954595
04AZB137	8 - 10mm	368-162	HT-10R	468-162	HTD-10R	568-362	SBM-10C	
04AZB138	10 - 12mm	368-163	HT-12R	468-163	HTD-12R	568-363	SBM-12C	
04AZA719	12 - 16mm	368-164	HT-16R	468-164	HTD-16R	568-364	SBM-16C	216556
04AZA720	16 - 20mm	368-165	HT-20R	468-165	HTD-20R	568-365	SBM-20C	
04AZA728	20 - 25mm	368-166	HT-25R	468-166	HTD-25R	568-366	SBM-25C	216557
04AZA729	25 - 30mm	368-167	HT-30R	468-167	HTD-30R	568-367	SBM-30C	
04AZA737	30 - 40mm	368-168	HT-40R	468-168	HTD-40R	568-368	SBM-40C	
04AZA738	40 - 50mm	368-169	HT-50R	468-169	HTD-50R	568-369	SBM-50C	
04AZA750	50 - 63mm	368-170	HT-63R	468-170	HTD-63R	568-370	SBM-63C	
04AZA751	62 - 75mm	368-171	HT-75R	468-171	HTD-75R	568-371	SBM-75C	216558
04AZA752	75 - 88mm	368-172	HT-88R	468-172	HTD-88R	568-372	SBM-88C	
04AZA753	87 - 100mm	368-173	HT-100R	468-173	HTD-100R	568-373	SBM-100C	
04AZA775	100 - 125mm	368-174	HT-125R	468-174	HTD-125R	—	—	—
04AZA776	125 - 150mm	368-175	HT-150R	468-175	HTD-150R	—	—	—
04AZA777	150 - 175mm	368-176	HT-175R	468-176	HTD-175R	—	—	—
04AZA778	175 - 200mm	368-177	HT-200R	468-177	HTD-200R	—	—	—
04AZA779	200 - 225mm	368-178	HT-225R	468-178	HTD-225R	—	—	—
04AZA780	225 - 250mm	368-179	HT-250R	468-179	HTD-250R	—	—	—
04AZA781	250 - 275mm	368-180	HT-275R	468-180	HTD-275R	—	—	—
04AZA782	275 - 300mm	368-181	HT-300R	468-181	HTD-300R	—	—	—
04AZB139	.275 - .35"	368-261	HT-.35"R	468-261	HTD-.35"R	568-461	SBM-.35"C	954595
04AZB140	.35 - .425"	368-262	HT-.425"R	468-262	HTD-.425"R	568-462	SBM-.425"C	
04AZB141	.425 - .5"	368-263	HT-.5"R	468-263	HTD-.5"R	568-463	SBM-.5"C	
04AZA721	.5 - .65"	368-264	HT-.65"R	468-264	HTD-.65"R	568-464	SBM-.65"C	216556
04AZA722	.65 - .8"	368-265	HT-.8"R	468-265	HTD-.8"R	568-465	SBM-.8"C	
04AZA730	.8 - 1"	368-266	HT-1"R	468-266	HTD-1"R	568-466	SBM-1"C	216557
04AZA731	1 - 1.2"	368-267	HT-1.2"R	468-267	HTD-1.2"R	568-467	SBM-1.2"C	
04AZA739	1.2 - 1.6"	368-268	HT-1.6"R	468-268	HTD-1.6"R	568-468	SBM-1.6"C	
04AZA740	1.6 - 2"	368-269	HT-2"R	468-269	HTD-2"R	568-469	SBM-2"C	
04AZA754	2 - 2.5"	368-270	HT-2.5"R	468-270	HTD-2.5"R	568-470	SBM-2.5"C	
04AZA755	2.5 - 3"	368-271	HT-3"R	468-271	HTD-3"R	568-471	SBM-3"C	216558
04AZA756	3 - 3.5"	368-272	HT-3.5"R	468-272	HTD-3.5"R	568-472	SBM-3.5"C	
04AZA757	3.5 - 4"	368-273	HT-4"R	468-273	HTD-4"R	568-473	SBM-4"C	
04AZA783	4 - 5"	368-274	HT-5"R	468-274	HTD-5"R	—	—	—
04AZA784	5 - 6"	368-275	HT-6"R	468-275	HTD-6"R	—	—	—
04AZA785	6 - 7"	368-276	HT-7"R	468-276	HTD-7"R	—	—	—
04AZA786	7 - 8"	368-277	HT-8"R	468-277	HTD-8"R	—	—	—
04AZA787	8 - 9"	368-278	HT-9"R	468-278	HTD-9"R	—	—	—
04AZA788	9 - 10"	368-279	HT-10"R	468-279	HTD-10"R	—	—	—
04AZA789	10 - 11"	368-280	HT-11"R	468-280	HTD-11"R	—	—	—
04AZA790	11 - 12"	368-281	HT-12"R	468-281	HTD-12"R	—	—	—
04AZA941	100 - 113mm	—	—	—	—	568-374	SBM-113C	216558
04AZA942	112 - 125mm	—	—	—	—	568-375	SBM-125C	
04AZA943	4 - 4.5"	—	—	—	—	568-474	SBM-4.5"C	
04AZA944	4.5 - 5"	—	—	—	—	568-475	SBM-5"C	

\* Adaptors are required to connect borematic head assemblies and borematic main body units. Sets and complete units include the correct adaptors for the included heads, while individual heads (purchased separately) do not.

Adaptors are not required for Vernier/Digimatic Holtests.

Separately purchased head assemblies are not covered by the guaranteed accuracy for holtests (368/468 series).